

OPERATING MANUAL

ACIS AA275 - Basic

Important: Please read the instruction manual carefully prior to installation and keep it for future reference.

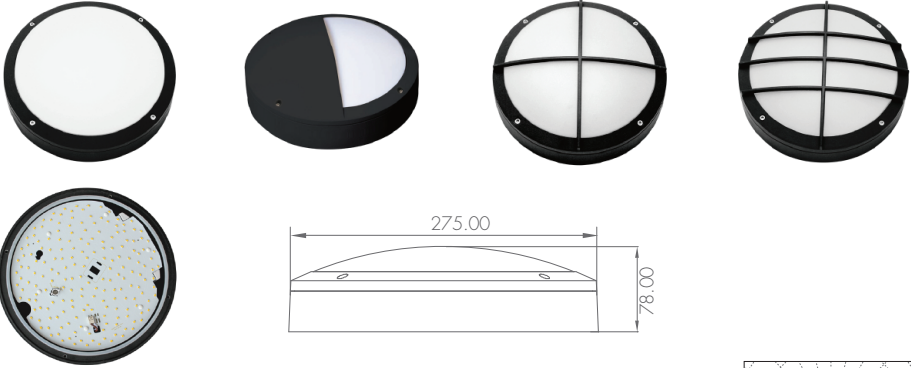

Ordering Code	Product	Power (W)	Function Description
	Fitting Series		
AA275 12 000	AA275	12	Basic LED
AA275 18 000	AA275	18	Basic LED

Mounting: Wall or Ceiling

Light features:

Ra: >80

Life Time: 5 years

Light Source: LED SMD2835

Input: 220V-240V 50/60Hz

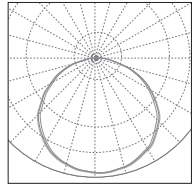

Color Temperature Code

Code	Color Temperature	CCT(K)	Lumen	
			12W	18W
			Eyelid	Standard/Cross/Grille
30K	Warm White	3000	810	1890
40K	Natural White	4000	840	1920
50K	Cool White	5000	860	1960

Accessories

No.	Pic.	Qty.	Usage
1		4	Fitting base
2		4	Rawl plug
3		4	Plastic washer
4		4	Waterproof silicone gasket

Installation

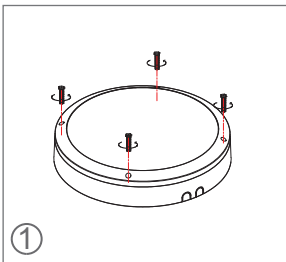

Remove the screws.

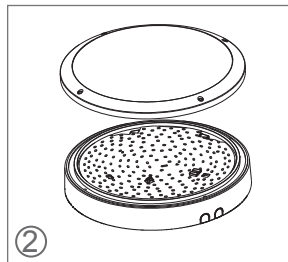

Remove the cover and unlock the lugs on PCB panel.

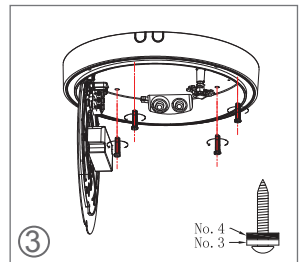

Knock the rawl plug into pre-drilled hole on the wall. Wear plastic washer and waterproof silicone gasket on the screw, then fix the fixture on wall.

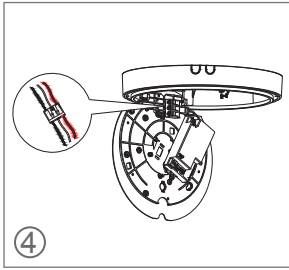

Wiring

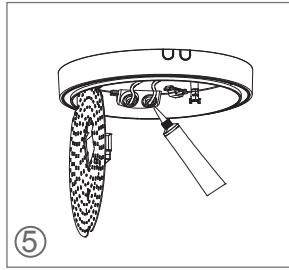

After wire connection, seal the punctured rubber plug with glue, to prevent water coming into fixture. Remark: No glue is offered.

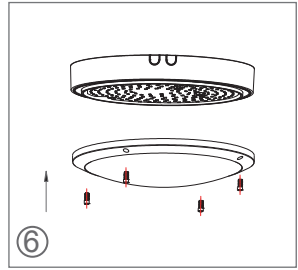

Lock the lugs then secure cover to base by tightening screws.

Wiring

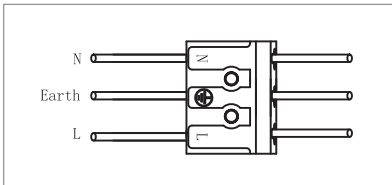

Maintenance

1. Cut off the main power first
2. Don't touch LEDs while maintaining or cleaning
3. Don't use chemicals to clean the fixture.

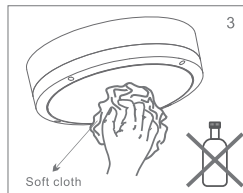
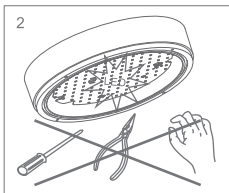
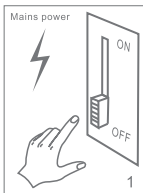

Environmental protection: waste electrical products should not be disposed of with household waste. Please recycle where facilities exist. Check with your local authority or retailer for recycling advice.



Caution

1. The product must be installed by professional technicians and power supply must be cut off before installation.
2. The diameter for AC input wire is 0.75mm² (complying with 60245 IEC57), which complies with the latest IEE electrical standards or national standards.
3. Do not touch the electronic circuit and its components.
4. Contact an authorised technical service centre for any repairs possibly required use only original spare parts.
5. Do not touch LED while installing or maintaining.
6. Sealing the entrance hole with glue after install is needed.
7. The light source contained in this luminaire shall only be replaced by the manufacturer or his service agent or a similar qualified person.

